

SPECIFICATIONS FOR NICHIA BLUE LASER DIODE BANK

Part No. NUBM0F

NICHIA CORPORATION

0. Application Coverage

Blue laser diode bank: NUBM0F

(In this specification, the blue laser diode bank is referred to as “LD-Bank”, and the laser diode with collimator lens mounted on the LD-Bank is referred as "LD".)

1. Specifications

(1) Features

Forward Current: 3.0A(CW Operation), $T_m=70^\circ\text{C}$, ACC(Auto Current Control) Operation

(2) LD-Bank Absolute Maximum Ratings

Item	Symbol	Absolute Maximum Ratings	Unit
Forward Current	I_F	3.5	A
Allowable Reverse Current	I_R	85	mA
Storage Temperature	T_{stg}	-40 ~ 85	$^\circ\text{C}$
Operating Temperature *1)	T_m	0 ~ 70	$^\circ\text{C}$

*1) Refer to Fig.1

(3) Initial Electrical/Optical Characteristics of LD-Bank

($T_m=22^\circ\text{C}$, equivalent to $T_b=27^\circ\text{C}$)

Item	Symbol	Test Condition	Min.	Typ.	Max.	Unit
Optical Output Power	P_o	$I_F=3.0\text{A}$	42	(44)	-	W
Dominant Wavelength *2)	λ_d	$I_F=3.0\text{A}$	450	(455)	460	nm
Forward Voltage *3)	V_F	$I_F=3.0\text{A}$	29	(33)	37	V
Beam Pointing Tilt Angle *4)	$\Delta\theta$	$I_F=3.0\text{A}$	-	-	0.7	$^\circ$

All figures in this specification are measured by Nichia's method and may contain measurement deviations.

() are reference figures.

*2) The average value of the dominant wavelength of the LDs.

*3) When connected in series with the 8 LDs.

*4) Beam Pointing Tilt Angle $\Delta\theta = \sqrt{\Delta\theta_{//}^2 + \Delta\theta_{\perp}^2}$ (Individual LD)

(4) Lifetime Characteristics of LD-Bank

Item	Symbol	Test Condition	Min.	Typ.	Max.	Unit
Estimated Lifetime *5) *6)	Life	Cumulative Failure Rate 50%	10000	(20000)	-	hrs
		Cumulative Failure Rate 1%	1000	-	-	hrs

() are reference figures.

*5) Condition: $T_m=70^\circ\text{C}$, ACC, $I_F=3.0\text{A}$ (CW)

*6) Calculation Method: Estimated in the linear extrapolation by degradation rate at tested duration 1000 hrs.

Criteria for Judging the Defect of Lifetime: $P_o \times 0.5$

Cumulative failure rate is calculated by the parameter greater than 500pcs.

(5) Initial Electrical/Optical Characteristics of LD

($T_c=25^\circ\text{C}$)

Item	Symbol	Test Condition	Min.	Typ.	Max.	Unit
Optical Output Power	P_o	$I_F=3.0\text{A}$	-	(5.4)	-	W
Dominant Wavelength *7)	λ_d	$I_F=3.0\text{A}$	448	(455)	462	nm
Threshold Current	I_{th}	CW Operation	240	-	440	mA
Slope Efficiency	η	CW Operation	-	(2.0)	-	W/A
Forward Voltage	V_F	$I_F=3.0\text{A}$	3.5	-	4.7	V
Beam Divergence *8)	Parallel	$\theta_{//}$	$I_F=3.0\text{A}$	0.65	(0.85)	$^\circ$
	Perpendicular	θ_{\perp}	$I_F=3.0\text{A}$	-1.0	(0)	$^\circ$

All figures in this specification are measured by Nichia's method and may contain measurement deviations.
 () are reference figures.

*7) λ_d is defined from trichromatic coordinate (x, y) values on chromaticity diagram calculated from the peak intensity higher than $1/e^2$ shown in Fig.2.

*8) Full angle at $1/e^2$ from peak intensity

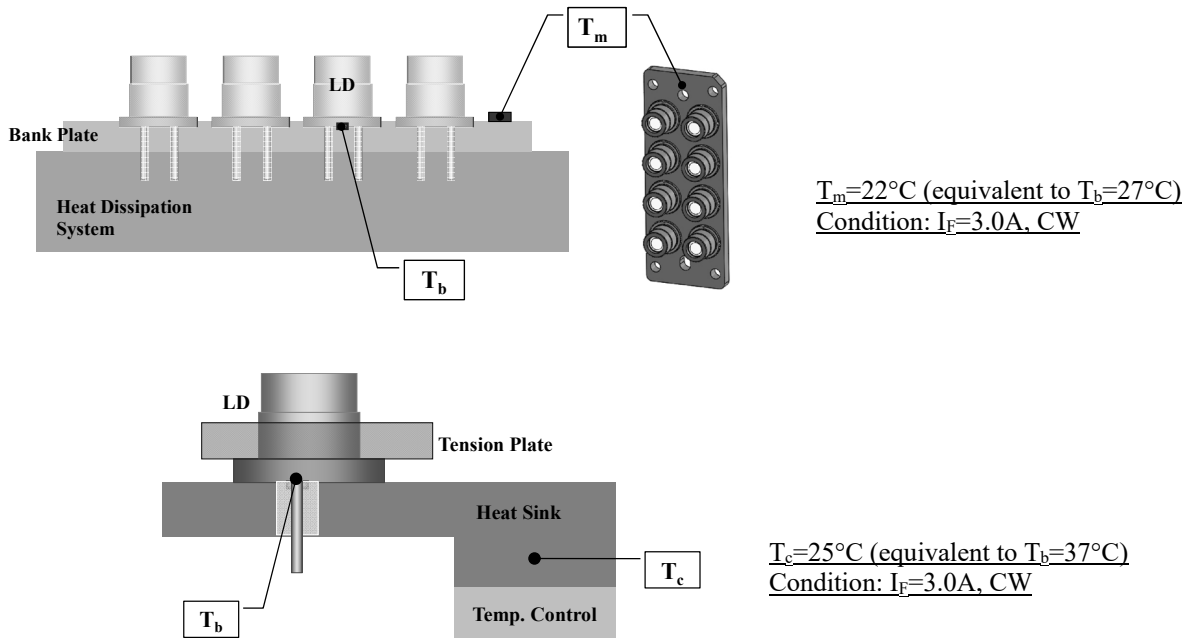

Fig.1 Schematic diagram of measurement system

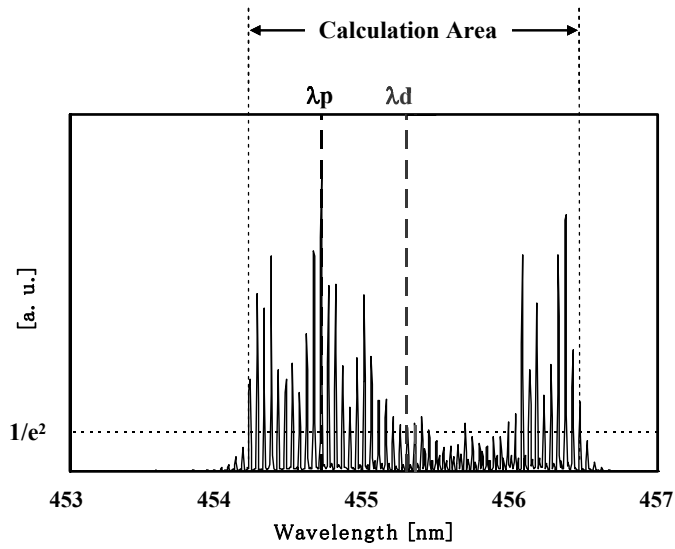

Fig.2 Definition of Dominant Wavelength

2. Outline Dimensions and Materials

Refer to the outline dimension pages within this specification.

3. Packaging

Refer to the packaging page within this specification.

4. Typical Initial Optical/Electrical Characteristics

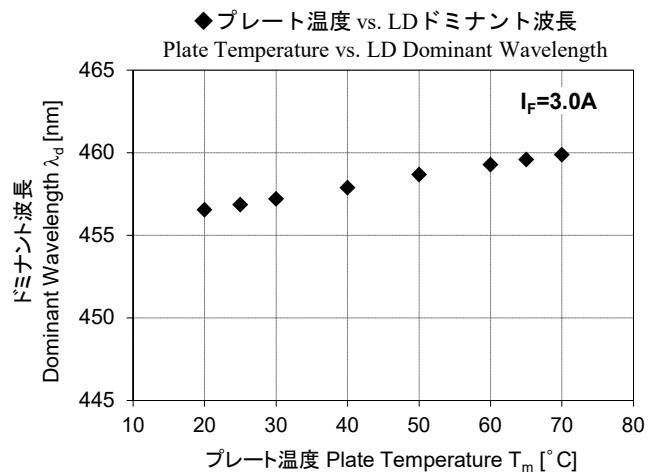
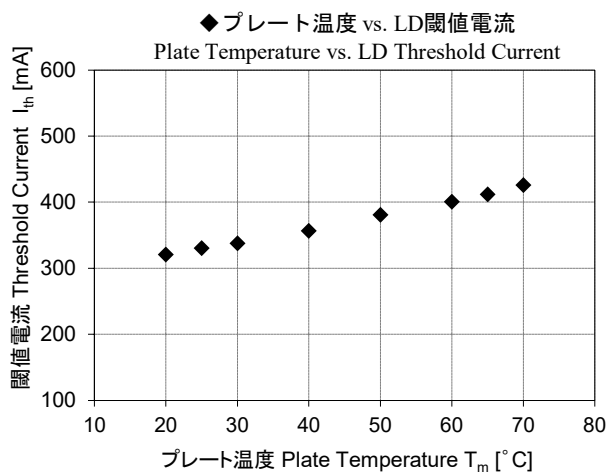
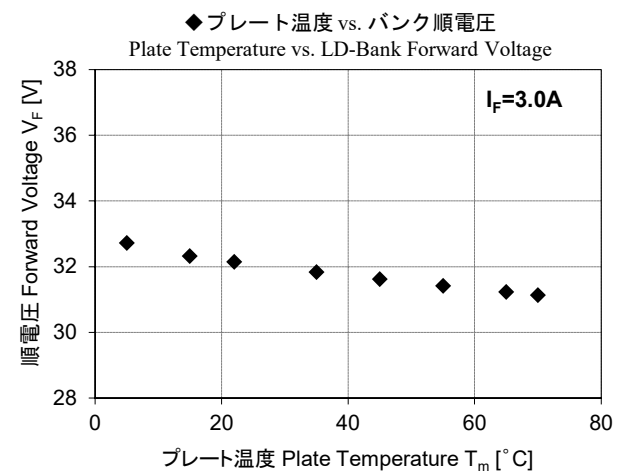
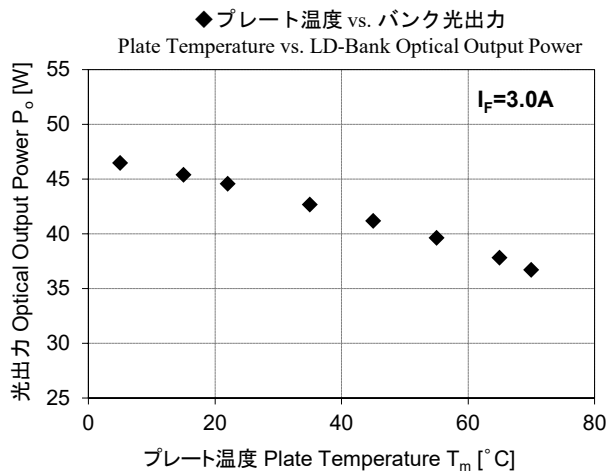
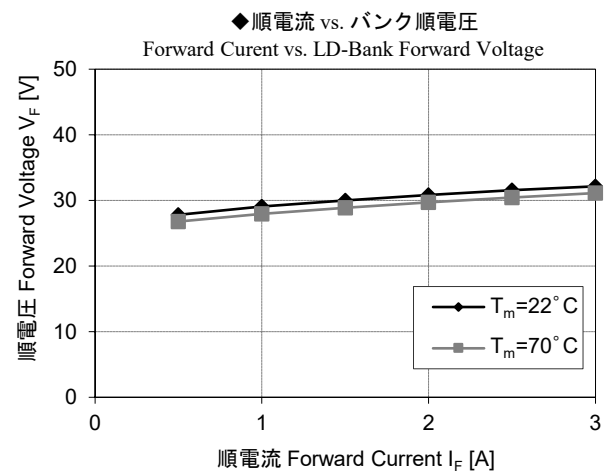
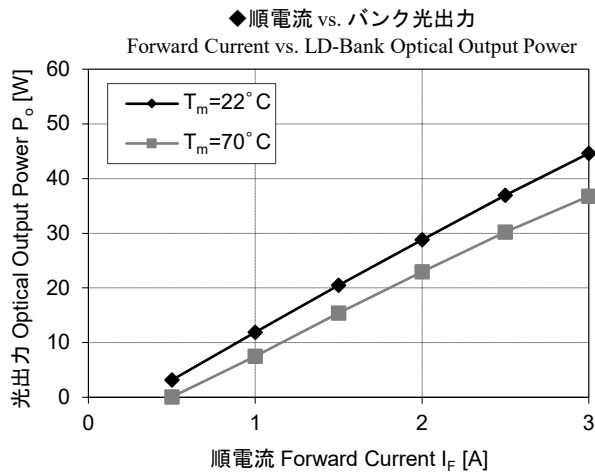

5. Reliability

(1) Test Items and Test Conditions

Test Item	Test Conditions	Note	Compliant Standard	Criteria for Judging
Resistance to Soldering Heat (Hand Soldering)	$T_{\text{slid}} = 350 \text{ }^{\circ}\text{C} \pm 10 \text{ }^{\circ}\text{C}$, 5 sec. (2mm from the base of the lead)	2 times		A
Solderability	$T_{\text{slid}} = 245 \text{ }^{\circ}\text{C} \pm 5 \text{ }^{\circ}\text{C}$, 5 sec. Lead-free solder (Sn-3.0Ag-0.5Cu)	1 time	JEITA ED-4701 301 303A	B
Temperature Cycle	-40°C (30min.) ~ 85°C (30min.)	100 cycles	JEITA ED-4701 100 105	A
Vibration	200 m/s ² , 100 ~ 2000 ~ 100Hz (4min.) 4 cycles of each X,Y,Z	48 min.	JEITA ED-4701 400 403	A
Shock	15000 m/s ² , 0.5ms X,Y,Z	3 times	JEITA ED-4701 400 404	A
High Temperature Storage	$T_A = 85 \text{ }^{\circ}\text{C}$	1000hrs.	JEITA ED-4701 200 201	A
Temperature Humidity Storage	$T_A = 85 \text{ }^{\circ}\text{C}$, RH = 85 %	1000hrs.	JEITA ED-4701 100 103	A
Low Temperature Storage	$T_A = -40 \text{ }^{\circ}\text{C}$	1000hrs.	JEITA ED-4701 200 202	A
Life Test	$T_m = 70^{\circ}\text{C}$, $I_F = 3.0\text{A}$ (CW), ACC Operation	1000hrs.		C

(2) Criteria for Judging the Failure

	Item	Symbol	Test Conditions	Criteria for Judging the Failure
A	Forward Voltage	V_F	$I_F = 3.0\text{A}$ (series)	>Initial value $\times 1.1$ <Initial value $\times 0.9$
	Optical Output Power	P_o	$I_F = 3.0\text{A}$	>Initial value $\times 1.1$ <Initial value $\times 0.9$
	Beam Tilt Angle	$\Delta\theta$	$I_F = 3.0\text{A}$	>Initial value +0.5deg. <Initial value -0.5deg.
B	Appearance	–	Solderability (LD)	Less than 95% (except for the 0.5mm from the lead tip)
C	Optical Output Power	P_o	Life Test Condition	>Initial value $\times 1.1$ <Initial value $\times 0.9$

6. Cautions

- Semiconductor devices, including Nichia laser diode Bank (the LD-Bank), can be damaged or fail in certain probability. The probability can be largely affected by the circuit used and/or environmental conditions. The following precautions should be carefully reviewed and followed to avoid the risk of any damage or failure.
- When incorporating the modules, equipment, systems, etc., the Purchaser must acknowledge that any LD-Bank can fail statically and must design its equipment fail safe designs to avoid consequential bodily and/or property damage.

1. LASER BEAM CAN DAMAGE EYES:

- Laser Light can damage the human eyes and skin. Do not expose the eye or skin to laser light directly. This Laser product has an optical lens and emits a collimated laser beam. The light from this product, both direct and reflected, is very harmful as it can propagate a long distance while maintaining high optical density. When handling the product, wear appropriate safety glasses to protect eyes from laser light including reflected and stray light. The reflected and stray light spilling into an unintended area should be attenuated and/or absorbed.
- When handling the LD-Bank, wear appropriate safety glasses to prevent laser light, even any reflections, from being exposed to the eyes.
- Use of the LD-Bank should conform to **Class 4 of the IEC60825-1 and 21 CFR Part 1040.10 Safety Standards.**



2. Static Electricity and Electrical Surges:

Static electricity or electrical surges will reduce and degrade the reliability of the LD-Bank. When working with the LD-Banks take countermeasures to avoid the generation of static electricity, including the following:

- Use or wear appropriate work clothes, gloves, shoes, grounded wrist straps and other tools to avoid static electricity.
- Wrist band must be grounded by high resistance (1M Ohm) wire.
- Use anti-static case for transport and storage of the LD-Bank.
- Use fully grounded workbenches, soldering tools, equipment and circuits. Especially, the soldering iron must be a leak-free type. Ground the equipment and the circuit to be connected, and surge current must be blocked at the power supply.
- Insulating materials will not release static electricity. Use an ion blower to neutralize the electrostatic.
- To prevent electrostatic generation, maintain an environmental humidity of more than 40%.
- Do not connect or disconnect oscilloscope probes or voltage meter cables when the LD-Bank is operated. That may cause a surge.
- Do not use the LD-Bank near a Glow Electric Discharge Tube or similar equipment, due to the chance of inducing an electrical surge by high frequency noise.

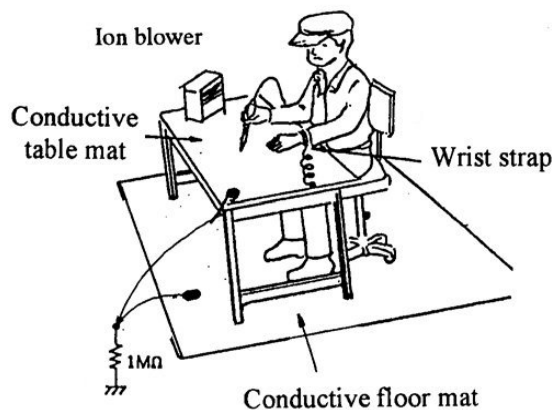

3. Absolute Maximum Ratings:

The active layer of the mounted LDs has a high current density and generates a high electric field during its operation. In order to prevent excessive damage, the LD-Bank must be operated strictly below the Absolute Max Rating.

The LD-Bank will have shorter lifetime if used at higher temperature. In order to elongate the lifetime, design the equipment to use the LD-Bank at lower temperature and lower output power.

During operation, if the forward current and/or optical output power are increased the lifetime of the LDs will decrease. Ensure that the LDs are operated within the recommended conditions.

4. Operating Power Supply:

When adjusting the operation current, make sure to simultaneously monitor the optical output power by using a power meter..

The LD-Bank will change its forward voltage requirement and optical output power according to the temperature change. Also, the LD-Bank will require a higher operation current to maintain the same output power as it degrades. In order to maintain the output power, use of an APC (Automatic Power Control) is recommended, which uses feedback of the optical output power to adjust the operation current.

Confirm that the electrical spike current generated by switching on and off does not exceed the maximum operating current as specified within this document as the absolute max rating. Additionally, ensure that there are appropriate countermeasures to reduce chattering and/or overshooting in the circuit.

ACC (Auto Current Control) mode is recommended for the operation of this product. Additionally, be careful for the overshooting in order to avoid excessive optical output power as the laser operation is started.

5. Design Consideration:

LDs may fail as either a short circuit or an open circuit. If an LD shorts during operation, the forward voltage of the LD may fluctuate greatly. When designing a circuit, ensure that both short and open circuits are considered and that there will be no issues if a short or open circuit occurs.

6. Heat Sink:

The use of heat sinks is strongly recommended to reduce increases in temperature and in the operating current of the LD-Bank. If the heat dissipation capability is not sufficient, the temperature of the LD-Bank will increase, light output power will decrease, and the LD-Bank could be damaged or destroyed due to escalating increases in temperature and in the operating current.

It is recommended that the plate of the LD-Bank should firmly touch the heat sink panel in order to efficiently dissipate heat. Heat sink characteristics depend significantly on its construction, materials and shape. The selection of the heat sink and the design of the circuit should take into account heat resistance and dissipation.

7. Storage:

Rapid fluctuations in the storage temperature and/or humidity should be avoided both before and after opening the antistatic bag. After opening the antistatic bag, the storage conditions should be a temperature within the range of 5°C to 35°C and a relative humidity within the range of 40% to 75%. Before opening the antistatic bag, any storage temperatures and humidity levels which are outside of those parameters should be avoided.

The plate of the LD-Bank and the leads and stems of mounted LDs are plated. The plating surface may be deteriorated by corrosive gases or similarity.

LD-Bank must be stored in clean atmospheric environment, and recommended to be assembled at the earliest timing.

The LD-Bank shall be used within one year after the receipt. Shelf life is one year.

8. Installation and Soldering:

Do not apply excessive stress to leads and caps / lens surfaces, because it may deteriorate hermetically. Excessive stress to the plate of the LD-Bank can cause the plate to deform or break, or cause deterioration to the LD characteristics.

- This product is designed to be hand soldered. If reflow soldered, Nichia cannot guarantee its reliability.
- Bending leads: Bend the leads of the LD at a point no closer than 2 mm from the base of a lead on the LD. Maximum bending angle is 90 degree.
- Tensile/Indentation load: Maximum tensile load or indentation load on lead is 5N.
- Soldering temperature: Keep soldering Iron at less than 350 degrees Celsius (662 degrees Fahrenheit), and for no longer than 3 seconds.
- Soldering position: Solder the leads at a point no closer than 2 mm from the base of a lead on the LD.
- Do not solder the plate of the LD-Bank directly onto the heat sink panel.
- Do not heat directly to the glass part of the base of a lead.
- Do not attach solder and others to the glass of part the base of a lead.

Do not add excessive stress to the plate of the LD-Bank. LD-Bank characteristics become impaired by package damage.

9. Beam Shape; Lens Care:

- The beam from the LD forms a collimated oval shape that has been corrected by the lens.
- The shape of the beam must be converged by the appropriate lens to conform to the utility of the circuit.
- Handle the LD-Bank carefully to avoid damage to or staining of its lens surface because those may cause to decrease light output power and change the beam shape.
- Due to its short wavelength and high optical output power, optical depositions on optical path may occur depending on surrounding conditions. Appropriate design or countermeasures should be used to avoid optical depositions.

7. Limited Warranty

Limited Warranty

- (1) Nichia warrants that the LD-Bank itself, not incorporated into any module, equipment and/or system designed and/or manufactured by any party other than Nichia, shall perform in accordance with its specifications. This warranty shall become immediately null and void if any of Nichia's instructions set forth above are not followed.
- (2) The Purchaser must acknowledge that any LD-Bank can statistically fail and must design its equipments in a fail safe design. It is Purchaser's responsibility to confirm that the LD-Bank, as described in Nichia's specifications, meets the life expectancy needs of, and provides the features required by the Circuit and any related modules, equipment and/or systems.
- (3) This LD-Bank is intended to be used for household appliances, electronic devices (e.g. mobile communication devices); it is not designed or manufactured for use in applications that require safety critical functions (e.g. aircraft, automobiles, combustion equipment, life support systems, nuclear reactor control system, safety devices, spacecraft, submarine repeaters, traffic control equipment, trains, vessels, etc.). If the LDs are planned to be used for these applications, unless otherwise detailed in the specification, Nichia will neither guarantee that the LD-Bank is fit for that purpose nor be responsible for any resulting property damage, injuries and/or loss of life/health.
This LD-Bank does not comply with IATF 16949 and is not intended for automotive applications.

Warranty Service

Warranty service is available during the one (1) year period commencing on the date of shipment from Nichia. During the Warranty Period, if the Purchaser finds failure or defect, following process shall be taken:

- (1) Fill in and send "Questions for Laser Damage Analysis" to Nichia and obtain Return Authorization Number (RA number)
- (2) Return to QA Manager Nichia Corp. 491 Oka, Kaminaka-Cho Anan-Shi, Tokushima 774-8601, JAPAN. The Purchaser must bear all packaging, handling, insurance and shipping costs that incurred related to returning the LD to Nichia.
- (3) Nichia shall conduct full analysis of the returned LD-Bank. If Nichia determines that the LD fails to meet the Limited Warranty above, Nichia will send the Purchaser equivalent quantity of replacement LD-Banks. If Nichia determines that the LD was damaged after the shipment from Nichia, Nichia shall contact the Purchaser, at which time the Purchaser may request either service of the LD by Nichia (at its standard fees therefore) or return of the LD to Purchaser.

Disclaimer of Warranties

NICHIA HEREBY DISCLAIMS ALL OTHER WARRANTIES INCLUDING, BUT NOT LIMITED TO, IMPLIED WARRANTIES OF MERCHANTABILITY AND FITNESS FOR A PARTICULAR PURPOSE.

Limitation of Liability

THE PURCHASER'S SOLE REMEDY IN THE EVENT OF A BREACH OF THE ABOVE WARRANTY SHALL BE, AT NICHIA'S OPTION AND IN ITS SOLE DISCRETION, REPAIR OR REPLACEMENT OF THE LD. NICHIA SHALL HAVE NO OTHER LIABILITY WITH REGARD TO ANY OTHER DAMAGES INCURRED BY PURCHASER WITH REGARD TO ANY DEFECTIVE LD, INCLUDING, BUT NOT LIMITED TO, LIABILITY RESULTING FROM ANY ACCIDENT, DAMAGE OR INJURY RELATED TO THE LD CAUSED BY ACCIDENT, MISUSE, ABUSE, NEGLIGENCE, MISAPPLICATION, INCORRECT USE OF ELECTRICAL VOLTAGE, ELECTRICAL FLUCTUATIONS OR SURGES CAUSED BY IMPROPER OR FAULTY INSTALLATION, IMPROPER CONNECTIONS WITH ANY OTHER CIRCUITS, SYSTEMS, PERIPHERALS OR LDS, LD ALTERATION OR MODIFICATION, UNAUTHORIZED REPAIR, COSMETIC DAMAGE OR CUSTOMER ADJUSTMENTS, USE OF UNAUTHORIZED PARTS OR EQUIPMENT WHICH DAMAGE OR CAUSE FAILURE OF THE LD, PROBLEMS DUE TO INCOMPATIBILITY WITH ANY OTHER MODULE, EQUIPMENT OR SYSTEM, OR ANY ACTS OF NATURE.

Reverse Engineering

Nichia prohibit Purchaser from reverse engineering, disassembling, or taking any other steps to derive the structure or design of the LD-Bank or mounted LDs. Any attempt to derive the structure or design of the LD shall be deemed breach of this Agreement, and shall make the limited warranty set forth above null and void.

Miscellaneous

- (1) Acceptance Test: The Purchaser shall perform an acceptance test on the LD-Bank within fourteen (14) days of the date of shipment by Nichia of the LD-Bank.
- (2) The formal specifications must be exchanged and signed by both parties before large volume purchase begins.
- (3) The appearance and specifications of the LD-Bank may be modified for improvement without notice.
- (4) The content of this specification may be revised without notice.

■ 外形寸法図 / Outline Dimension(1)

本図面 () 内の数値は参考値
 Figures in () are reference purpose only.

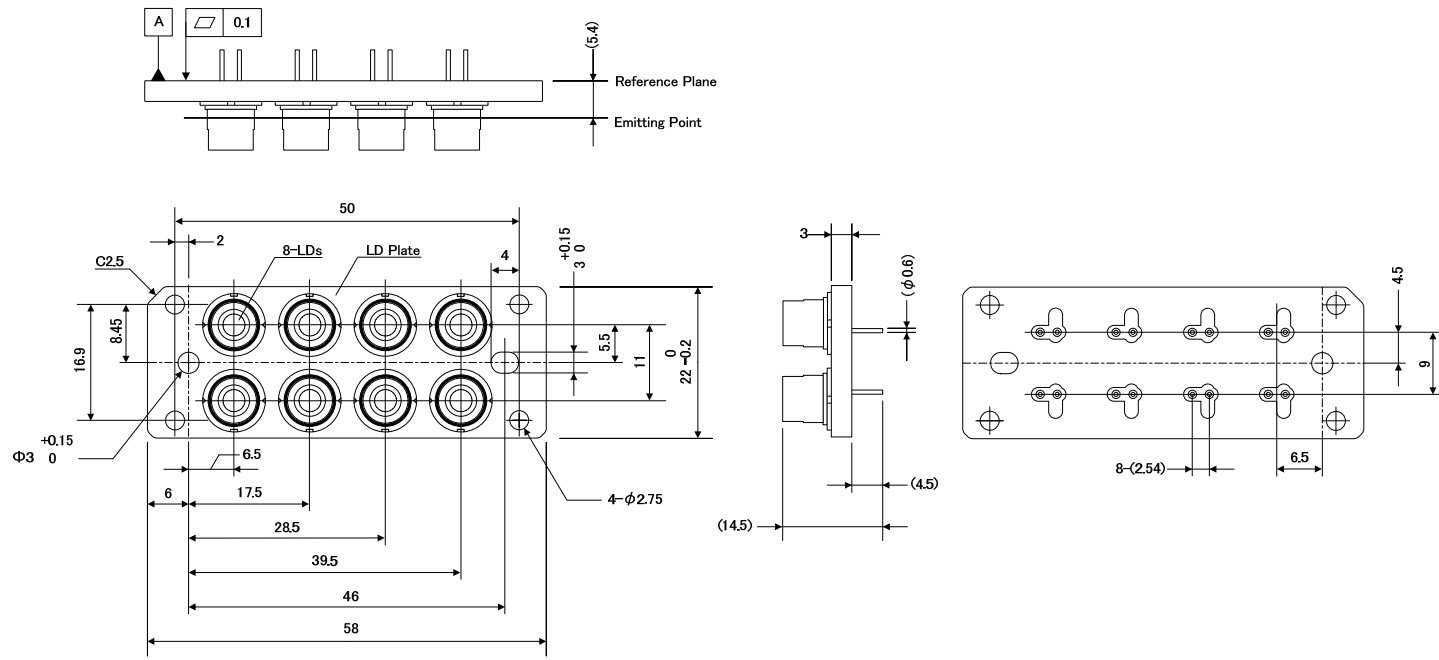

※Note
 TOLERANCES based on JIS B 0405-m(Table), UNLESS NOTED

Table, Limits for Linear measures(mm)

Range	0.5 to 3	above 3 to 6	above 6 to 30	above 30 to 120
Tolerance	±0.1	±0.1	±0.2	±0.3

Part No. NUxMxxE / NUxMxx	Title 外形寸法図 OUTLINE DIMENSION	Unit mm Scale
NICHIA CORPORATION	No. UTZ-ZAH05571	

■ 外形寸法図 / Outline Dimension(2)

Connection

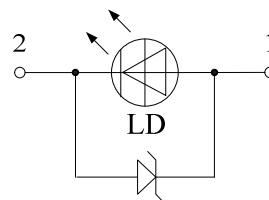
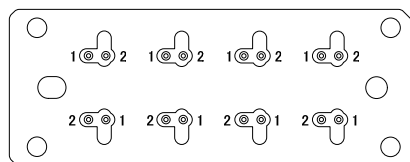
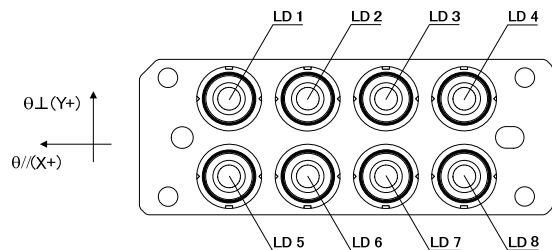

Zener Diode

- 1. LD Anode
- 2. LD Cathode

部品 Parts	材質 Materials
ステム Stem	Cu+Fe+Niめっき+Auめっき Cu + Fe + Ni plating + Au plating
リード Lead	Ni-Fe-Co合金+Niめっき+Auめっき Ni - Fe - Co alloys + Ni plating + Au plating
キャップ Cap	Fe-Cr合金 Fe - Cr alloys
レンズ Lens	光学ガラス Optical glass
チップ Chip	窒化ガリウム Gallium nitride
サブマウント Sub mount	窒化アルミニウム Aluminum nitride
Zener Diode	シリコン Silicon
LDプレート LD plate	Cu+Niめっき Cu + Ni plating
半田 Solder	Sn-Ag-Cu Sn - Ag - Cu

Section	Approve	Check	Draw	Unit
LDT	Ochiai	Iwasa	Yoshihara	mm
Date	Dec. 3, 2019			Scale
Part No.	外形寸法図			Allow
NUxMxxE / NUxMxx	OUTLINE DIMENSION			
NICHIA CORPORATION	No. UTZ-ZAH05571			

帯電防止袋
(真空パック)
Static-sealed bag
(Vacuum Packing)

Label

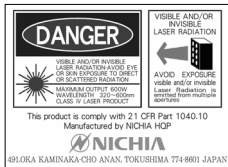

1トレイにつきLDバンク最大5台
The Tray contains 5 LD Bank at maximum.

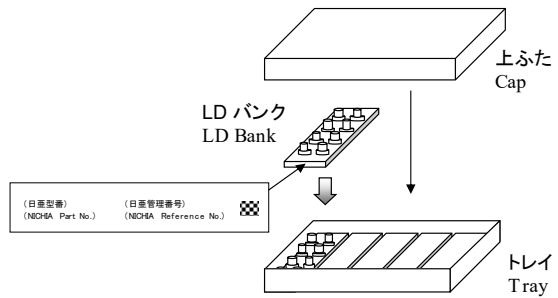

トレイ組立て後の寸法 W:134 × H:22 × D:86 [mm]
After assemble W:134 × H:22 × D:86 [mm]

< 外箱 Exterior Packaging >

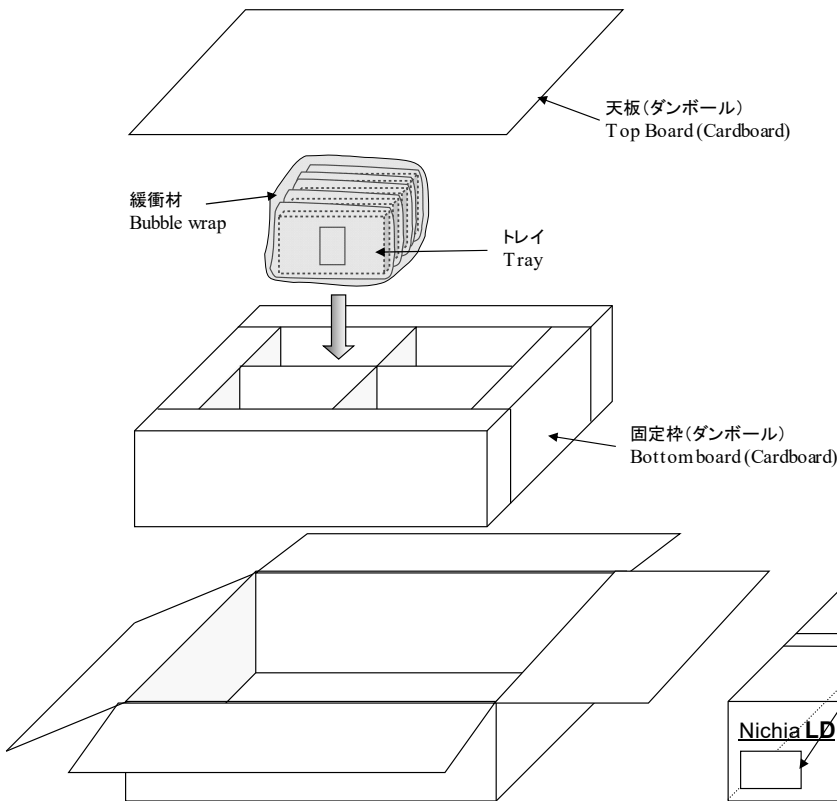

Label

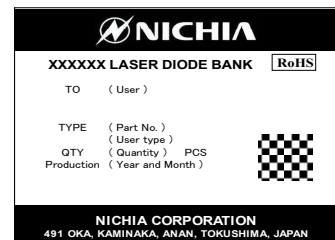

* 要望なき場合、ユーザ型番は印刷されることがあります。
User type might not be printed when not request.

外箱(ダンボール) W: 395 × H: 145 × D: 325 [mm]
外箱1箱につき最大20トレイ
Outer Box (Cardboard): W:395 × H:145 × D:325 [mm]
The Outer box contains 20 Trays at maximum

	Section	Approve	Check	Draw	Scale
	LDT	Ochiai	Iwasa	Asuka	
	Date	Oct. 29, 2021			
	Title	梱包仕様図 PACKAGING			Allow
NICHIA CORPORATION	No.	UTZ-ZAK06761			